

VIpower: dimmable driver for high brightness LEDs with VIPer22A-E

Introduction

This application note introduces an innovative solution to drive high brightness 1W LEDs (Light Emitting Diode), using VIPer22A-E in flyback configuration with output current control.

The power supply is able to drive an array of 1 to 8 LEDs in European range, i.e. 185-265 VAC with no modifications. By means of an input voltage doubler, it is possible to use the same VIPer device also in U.S. input voltage range, guaranteeing the specs. A new control technique is used to adjust the duty cycle of the output current, in order to dim the luminosity of the LEDs down to 10% of the maximum value (patent pending by STMicroelectronics).

The proposed driver can be suitably used in applications such as landscape lighting, street lighting, car parks, bollards, garden lighting, large area displays and so on.

Also domestic applications such as room lighting, decorative fixtures and architectural lighting can benefit from the advantage of this dimmable light source.

10W Dimmable LEDs driver board layout

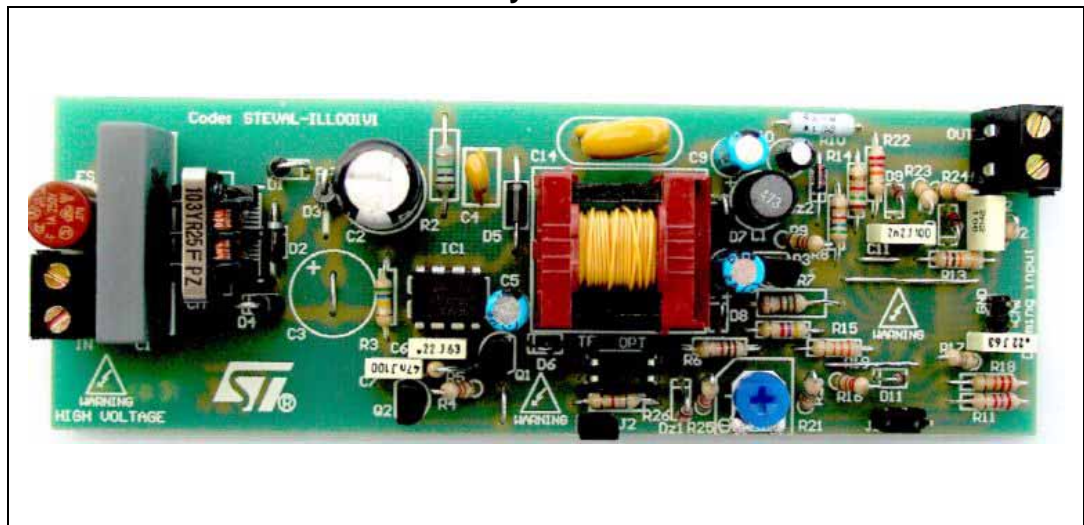

Contents

1	Light sources	4
2	Light emitting diode and colour vision	5
3	Commercial LEDs	7
4	New dimming technique	8
5	Application description	11
	5.1 Dimming control circuit	12
	5.2 Transformer specifications	16
	5.3 DALI Interface	16
6	Experimental results	18
7	Layout considerations	23
8	EMI measurements	24
9	Non dimmable version	25
10	Input section arrangement for U.S. market	26
11	Conclusions	27
12	Revision history	29

List of figures

Figure 1.	Light emitting diode structure	5
Figure 2.	The electromagnetic spectrum and visible region of light	6
Figure 3.	Human relative vision curve	6
Figure 4.	C.I.E. chromaticity diagram.	7
Figure 5.	Forward current vs. forward voltage in a typical commercial LEDs	8
Figure 6.	PWM technique for dimming.	9
Figure 7.	Brightness variation versus duty cycle	9
Figure 8.	Dimming technique using series switch	10
Figure 9.	Dimming technique using the new methodology	10
Figure 10.	New dimming technique: typical waveforms.	11
Figure 11.	Converter schematic for European input voltage range	14
Figure 12.	Transformer features: (a) schematic, (b) mechanical characteristics and (c) pinout	17
Figure 13.	V_{DS} and I_D at 230 V_{AC} : 1 LED	18
Figure 14.	V_{DS} and I_D at 230 V_{AC} : 8 LEDs	18
Figure 15.	Typical waveforms: drain voltage and output current ripple at 230 V_{AC}	19
Figure 16.	Typical waveforms: startup at 265 V_{AC}	19
Figure 17.	Drain voltage V_{DS} and output current I_{OUT} : 1 LED	19
Figure 18.	Drain voltage V_{DS} and output current I_{OUT} : 8 LEDs	19
Figure 19.	Drain voltage V_{DS} and output current I_{OUT} at 50% dimming: 1 LED	20
Figure 20.	Drain voltage V_{DS} and output current I_{OUT} at 50% dimming: 8 LEDs	20
Figure 21.	Drain voltage V_{DS} and output current I_{OUT} at 10% dimming: 1 LED	20
Figure 22.	Drain voltage V_{DS} and output current I_{OUT} at 10% dimming: 8 LEDs	20
Figure 23.	Control signals at 230 V_{AC} : 1 LED	21
Figure 24.	Control signals at 230 V_{AC} : 8 LEDs	21
Figure 25.	Control stage at 230 V_{AC} : 1 LED	21
Figure 26.	Control stage at 230 V_{AC} : 8 LEDs	21
Figure 27.	Open load condition at 230 V_{AC} : no dimming	22
Figure 28.	Open load condition at 230 V_{AC} : minimum dimming	22
Figure 29.	Efficiency	22
Figure 30.	PCB layout (not in scale)	23
Figure 31.	Conducted emissions at full load: line 1 emissions	24
Figure 32.	Conducted emissions at full load: line 2 emissions	24
Figure 33.	Non dimmable solution	25
Figure 34.	Application circuit for U.S. input voltage range: changes on the input section	26
Figure 35.	STEVAl-ILL001V1 Schematic	28

1 Light sources

Incandescent lights are basically electric space heaters that give off light as a by-product. They are very inefficient, wasting most of the power they consume as heat.

An innovative light source is represented by LED technology, with very low power consumption and virtually no heating effect, making LEDs ideal for several domestic and commercial applications.

The long lifetime characteristic of LEDs means savings on maintenance costs. Unlike traditional light sources, LEDs are not subject to sudden failure or burnout. Since LED based light sources last at least 10 times longer than a normal light source (up to 10 years or 100.000 hours for the higher quality products), it is possible to reduce or eliminate the maintenance ongoing costs.

This can be useful in many critical applications where the location makes replacement difficult (radio tower, aircraft warning lights, bridge and tunnel lights...) or in applications where a failure of the light source is not acceptable (emergency exit lights, back up lighting, security lighting...).

LED lighting technology features many advantages compared to conventional lighting:

- Higher energy efficiency, in terms of lumens per watt;
- Direct light beam for increasing system performance;
- Dynamic color control technology;
- Full dimmable without color variation;
- No mercury and no UV or heat in light beam;
- Low voltage operation, suitable for safety purpose in SELV systems.

The most important limitation for using high brightness LEDs is the manufacturing cost, which is still relatively high.

In [Table 1](#) a comparison between traditional light sources and a typical commercial LED is shown.

Table 1. Performance of typical light sources compared with white Luxeon LEDs

Lighting source	Luminous efficiency (lm/W)	Lifetime (hours)	Theoretical optical power (min and max)
Incandescent bulbs	18 ÷ 25	1000 – 2000	15 – 1000 W
Halogen lamps	15 – 25	2000 – 5000	5 – 2000 W
Fluorescent lamps	60 – 110	14000 – 20000	4 – 60 W
Mercury lamps	15 – 60	12000 – 24000	50 – 1000 W
LEDs (white luxeon)	25	100000	0.7 – 5 W

2 Light emitting diode and colour vision

Light-emitting diodes (LEDs) used for illumination are solid-state devices that produce light by passing electric current across layers of semiconductor chips that are housed in a reflector, which in turn is encased in an epoxy lens. The semiconductor material determines the wavelength and subsequent color of the light. The lens converts the LED into a multidirectional or unidirectional light source based on specification.

The first generation of LED was based on Gallium Arsenide (GaAs), Gallium Arsenide Phosphide (GaAsP), Gallium Phosphide (GaP) technology, but thanks to the growth of solid state technology, new structures have been introduced based on Aluminum Indium Gallium Phosphide (AlInGaP), Indium Gallium Nitride (InGaN) or Gallium Aluminum Arsenide (AlGaAs), mainly for the high brightness LEDs branch.

In [Figure 1](#) the basic LED structure and the energy bands are shown.

Figure 1. Light emitting diode structure

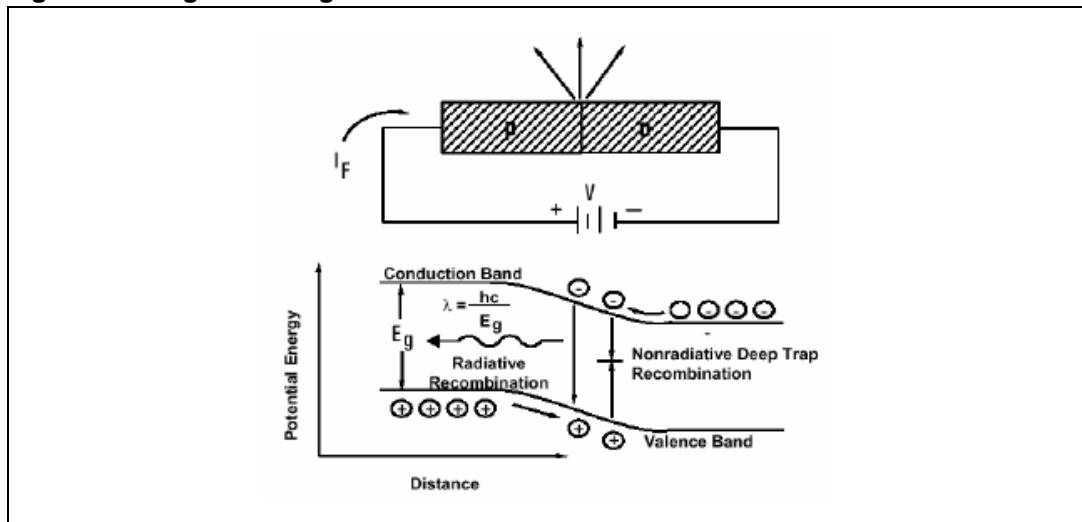

The junction in an LED is forward biased and when electrons cross the junction from the n to the p type material, the electron-hole recombination results in a process called electroluminescence: when the applied voltage drives the electrons and holes into the active region between the n-type and p-type material, the energy can be converted into infrared or visible photons. This implies that the electron-hole pair drops into a stabler bound state, releasing energy on the order of electron volts by emission of a photon of energy, according to ([Equation 1](#)).

Equation 1

$$E_g = h_c \cdot \nu = \frac{h_c}{\lambda}$$

The human eye is excited in response to electromagnetic radiations with wavelengths in a tight range of the electromagnetic spectrum, as shown in [Figure 2](#), from 400 nm to 700 nm which corresponds to extreme red and violet respectively.

Figure 2. The electromagnetic spectrum and visible region of light

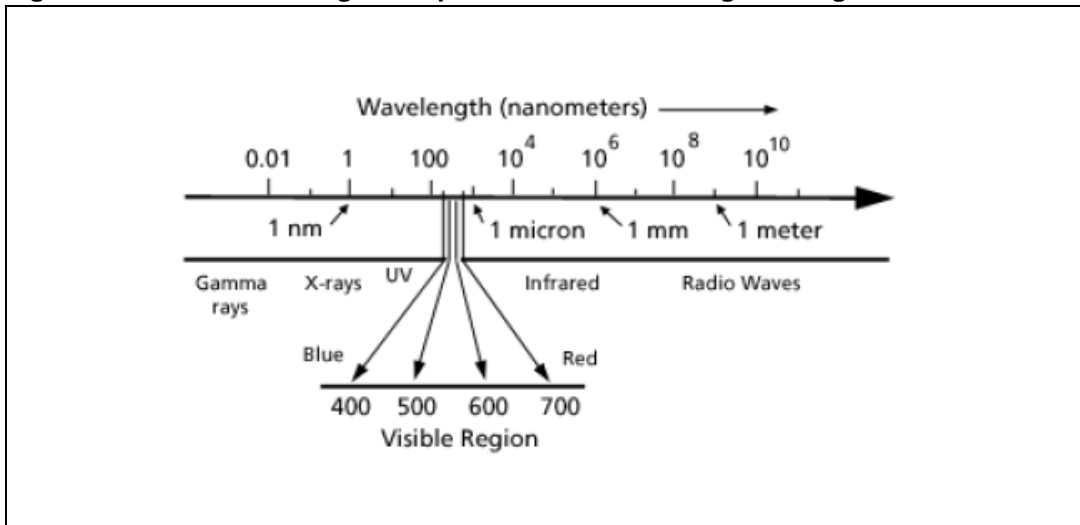

The red extreme of the visible spectrum, 700 nm, requires an energy release of 1.77 eV to provide the quantum energy of the photon. At the other extreme, 400 nm in the violet, 3.1 eV is required.

The human vision efficacy is not constant in the entire visible region, but decreases near the edges, as shown in [Figure 3](#) featuring a peak value for a wavelength of 555 nm (green-yellow).

Figure 3. Human relative vision curve

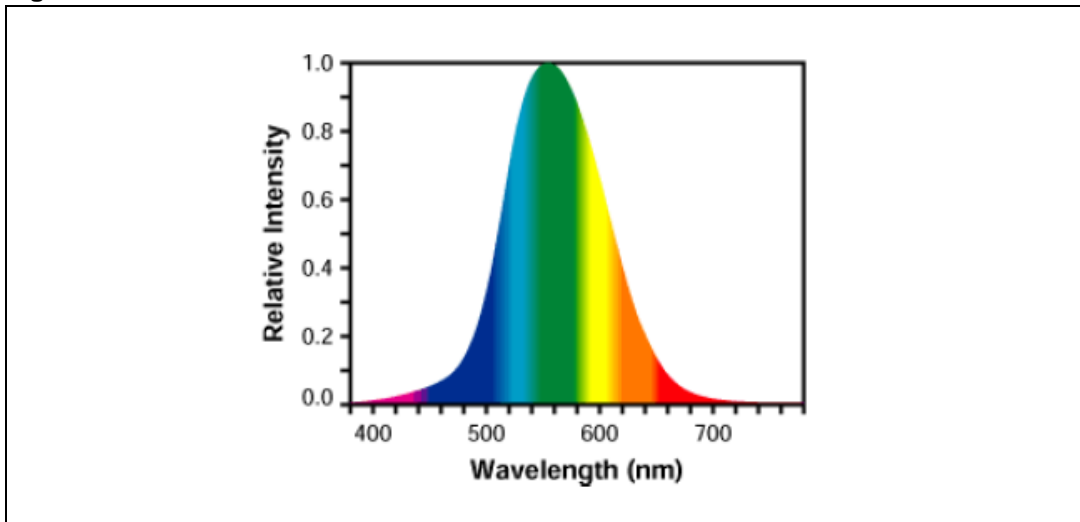

Wavelength can be defined in terms of dominant wavelength and x-y chromaticity coordinates, which define the color as perceived by the human eye. The dominant wavelength is derived from the C.I.E.

(Commission Internationale de l'Eclairage - International Commission on Illumination) Chromaticity Diagram, as shown in [Figure 4](#) This is an international standard for primary colors established in 1931. Based on the fact that the human eye is able to separately sense three different portions of the spectrum (we identify these peak sensitivities as red, green and blue), the eyes response is best described in terms of such primary colors. All the other colors are defined as weighted sum of them.

Figure 4. C.I.E. chromaticity diagram

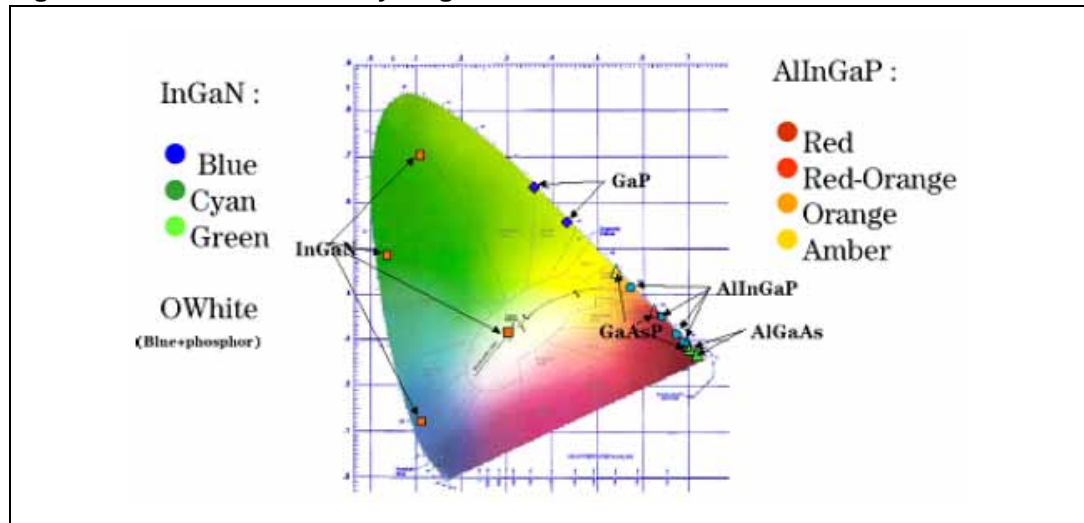

3 Commercial LEDs

In the last years, light emitting diodes can be chosen from a wide variety of products designed to meet specific needs to provide more efficient, longer life time alternatives to traditional incandescent lamps.

They are manufactured of GaN and related compounds of AlGaN and InGaN due to the wide bandgap, which allows emission of light ranging from the red to the ultraviolet (UV) wavelength. Blue and green LEDs are of special interest and are being used in a wide range of applications from outdoor video displays to automotive and cell phone backlights. LEDs for solid-state white lighting offer high efficiency, long lifetime and a high degree of design flexibility for a variety of lighting applications.

Thanks to new solid state technology, it now delivers from 25 to more than 120 lm/W in white and comparable light output in other colors. In [Table 2](#) are listed the main specifications for typical commercial high efficiency LEDs are listed, while [Figure 5](#) shows a typical V-I characteristic for a high efficiency LED.

Table 2. Typical characteristic for commercial LEDs (from Luxeon)

Color	Operating voltage (V)	Operative forward current (mA)	Dominant wavelength/ color temperature	Typical luminous flux (lm)
White	3.42	350	5500 K	18
Blue	3.42	350	470 nm	5
Cyan	3.42	350	505 nm	30
Green	3.42	350	530 nm	25
Amber	2.85	350	590 nm	20
Red	2.85	350	625 nm	25

Figure 5. Forward current vs. forward voltage in a typical commercial LEDs

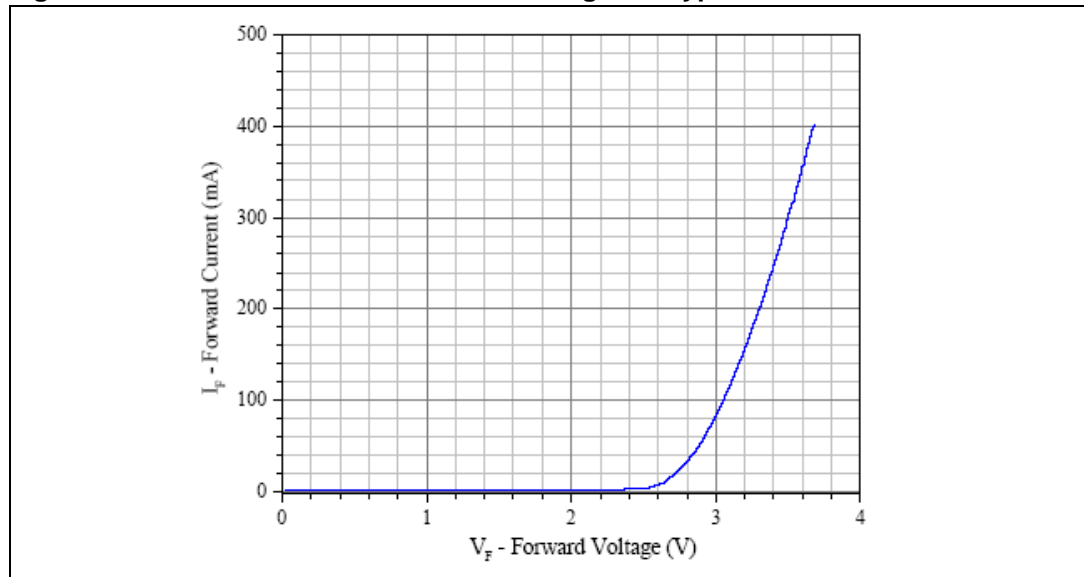

4 New dimming technique

Nowadays, thanks to the growth of process, packaging and thermal transfer technologies, light output continues to evolve. This involves especially the InGaN technology, which produces light output across blue, cyan, green and white, with high reliability and efficiency.

The wavelength of the light emitted is strongly dependent on the forward current driven through the device and in order to avoid shifts in color the dimming strategies have to be chosen carefully.

The most common method of dimming a LED is by varying either forward current or voltage across it. Unfortunately, due to the characteristics of InGaN, varying current or voltage will shift the wavelength. This effect is proportional to the wavelength, with the longer wavelengths undergoing the strongest shift variation versus current.

In many applications this effect cannot be accepted and, employing a PWM technique, it is possible to dim a LED in the right manner, without wavelength shift.

The LED is switched on and off at constant forward current (I_F) by varying the duty cycle, as shown in [Figure 6](#).

If the PWM frequency is higher than 100 Hz, the human eyes cannot perceive the single pulses, but they integrate and interpret those pulses as brightness, which can be changed linearly by varying the duty cycle linearly, with no wavelength shift. [Figure 7](#) shows the brightness variation versus duty cycle.

Figure 6. PWM technique for dimming

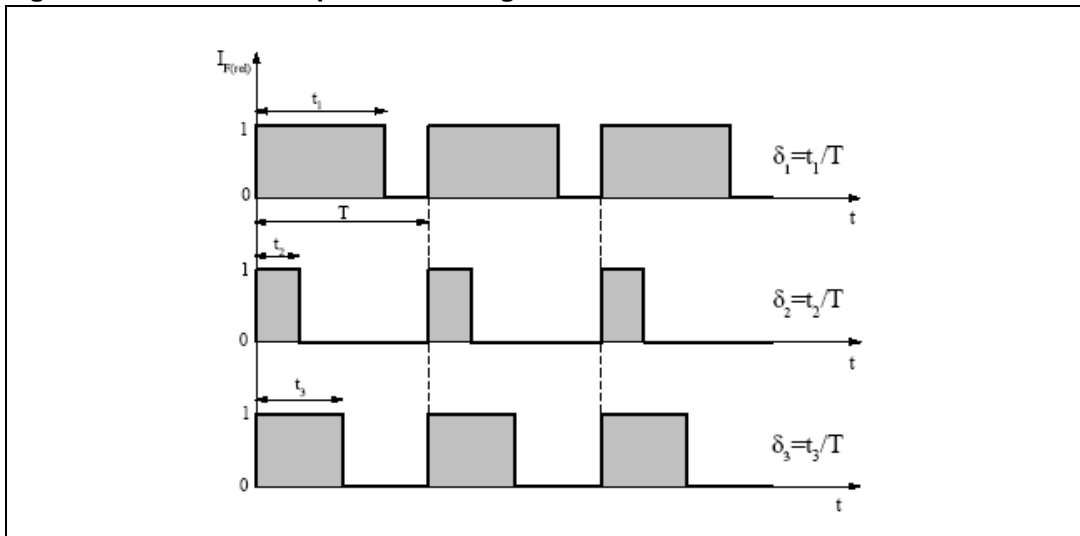
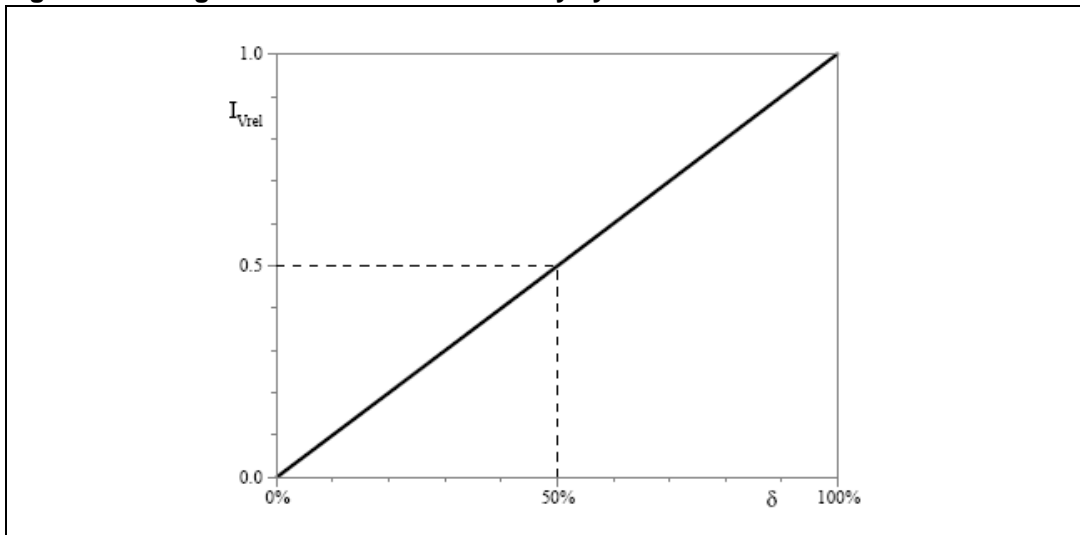

Figure 7. Brightness variation versus duty cycle



As shown in [Figure 8](#), the most common method to dim LEDs consists in a series connection of a power switch which is controlled by PWM.

Due to the relatively high operative forward current, the switch has to be selected carefully in order to handle the conduction losses.

Figure 8. Dimming technique using series switch

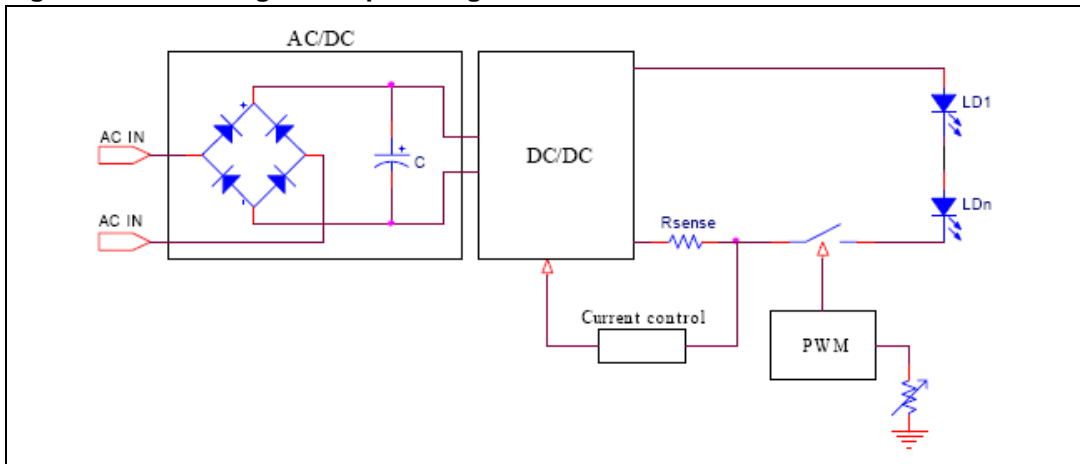

To overcome this problem, a patented solution has been implemented, which allows to eliminate the series switch, with a considerable improvement in terms of efficiency.

The new technique consists in a double control loop: a current and a voltage control loops. The first one drives the LEDs with constant current when the maximum luminosity is required. During the dimming operation, the current control loop will still limit the maximum output current, while the voltage loop will maintain the output voltage below the threshold voltage of the LEDs array. Also disconnecting the LEDs, the maximum output voltage will be limited by the voltage loop. In [Figure 9](#) and [Figure 10](#) the block diagram of the new dimming technique and the temporal diagrams are respectively shown. Thanks to the absence of the power switch, it is possible to have a more efficient and cheaper solution.

Figure 9. Dimming technique using the new methodology

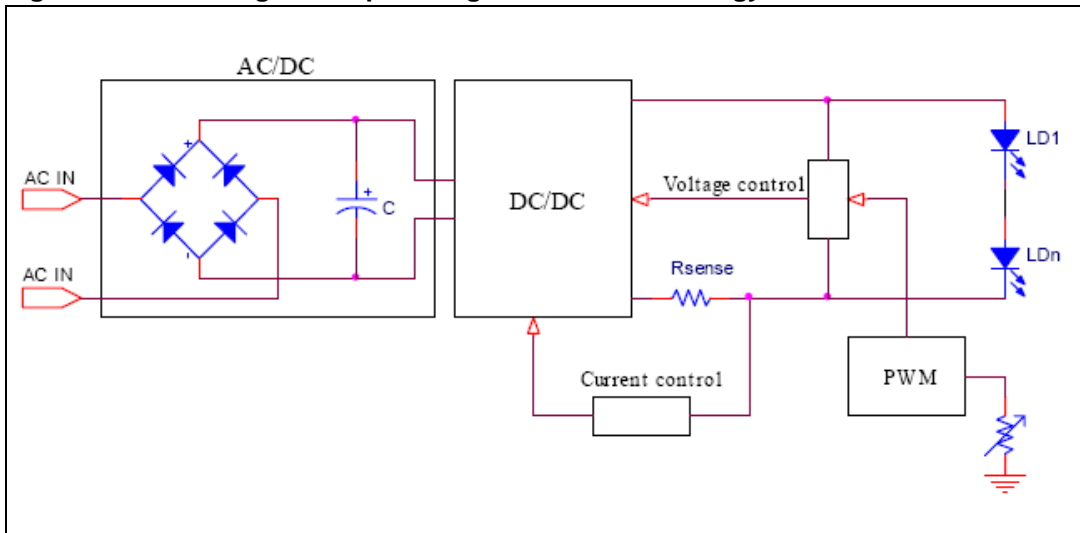
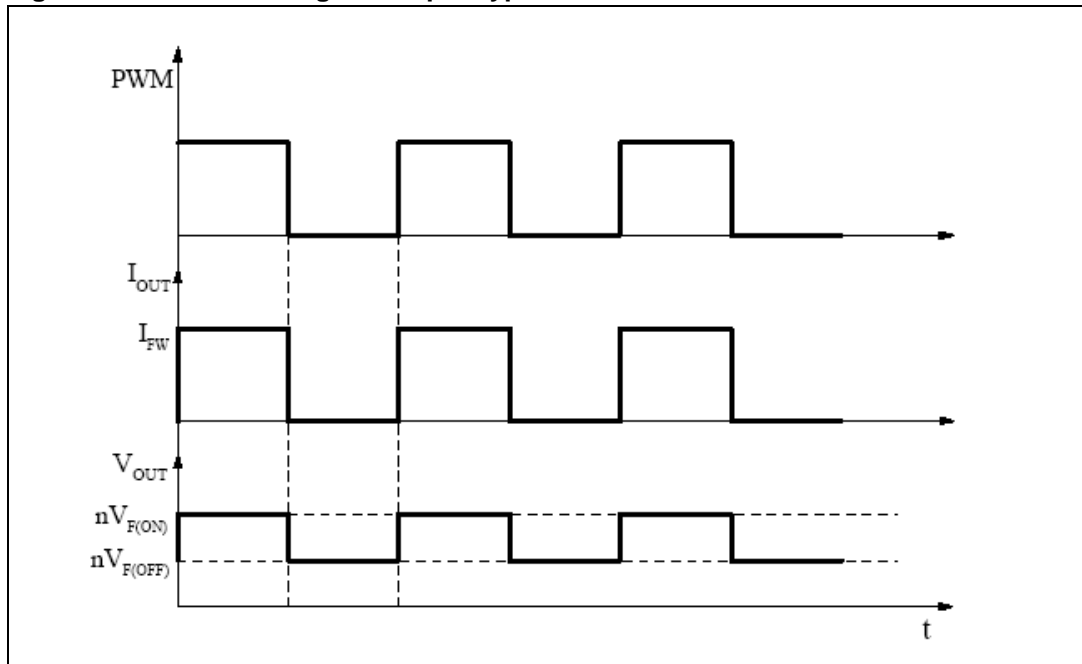

Figure 10. New dimming technique: typical waveforms



5 Application description

The proposed converter is based on VIPer22A-E, a smart power with a current mode PWM controller, startup circuit and protections integrated in the same monolithic chip, using STMicroelectronics VIPower M0 Technology. The power stage consists in a vertical Power MOSFET with 730 V breakdown voltage and 0.7 A typical peak drain current.

The application consists in an isolated constant current power supply, intended to supply an array of eight high efficiency LEDs, as shown in [Figure 11](#).

The board has been designed referenced to the specifications listed in [Table 3](#) It is important to highlight that the converter works in single range, but both U.S. and European range can be selected, with only a few modifications in the input section.

Table 3. SMPS Specifications

Parameters	Value
Selectable Input voltage range	85V _{AC} ÷135 V _{AC} or 185 V _{AC} ÷265 V _{AC}
Nominal output voltage range	3.5 V÷28 V
Maximum output voltage at open load	32 V
Output current	350 mA
Dimming range	0%÷90%
EMI Standard	EN55015:2000

In the input stage, an EMI filter is implemented (C_1 , CM, C_2) for both differential and common mode noise, in order to fit the EN55015:2000 standard (limits for electrical lighting and similar equipment). The input resistor R_1 , limits the inrush current of the capacitors at plug-in and a standard fuse is also introduced to prevent catastrophic failure.

The clamping network (R_2 - C_4 - D_5), limits the peak of the leakage inductance voltage spike, assuring reliable operation of the VIPer22A-E.

The auxiliary winding on the primary side, is connected in forward mode, since the output voltage ranges from 3.5 V to 28 V and the voltage on VDD pin varies from 17 V to 24 V.

A brown-out circuit (R_3 , R_4 , R_5 , Q_1 , Q_2 and C_7) is implemented in order to avoid the flickering of the LEDs during switch off. The values of R_3 , R_4 and R_5 are chosen in order to get the given thresholds, while C_7 stabilizes the voltage on the base of Q_1 .

The output filter selection is a very critical point to consider during the design. Since LEDs are switched on and off during the dimming phase the value of the output capacitor has to be as low as possible.

Therefore, in order to avoid exceeding the maximum output current ripple, care must be paid to design the right LC post filter.

5.1 Dimming control circuit

The current loop is controlled by the second operational amplifier of TSM104W and the sense resistor R_{10} . The voltage threshold is generated by means of a resistor bridge (R_{12} , R_{13} and R_{14}) connected to the 2.5 V internal voltage reference V_{REF} . The resistors of the bridge should be 1% precision in order to get the best precision on the regulation. The current control equations are given by ([Equation 2](#)) and ([Equation 3](#)).

Equation 2

$$V_{(Iout)} = \frac{V_{REF} \cdot R_{14}}{R_{12} + R_{13} + R_{14}}$$

Equation 3

$$I_{OUT} = V_{(Iout)} \cdot R_{10}$$

The sense resistor R_{10} , is chosen taking into account the maximum dissipation during full load. The voltage loop is controlled by the third operational amplifier and the voltage divider R_8 and R_9 directly connected to the output. The values are chosen according the equations ([Equation 4](#)) and ([Equation 5](#)).

Equation 4

$$V_{Oref} = \frac{V_{REF} \cdot (R_{13} + R_{14})}{R_{12} + R_{13} + R_{14}}$$

Equation 5

$$V_{Oref} = \frac{V_{OUT(MAX)}}{R_8 + R_9}$$

Where $V_{OUT(MAX)}$ is the maximum acceptable output voltage, when the LEDs array is disconnected. The transistor Q_3 , connected to the dimming control section, is ON during normal operation.

The feedback to the primary side is achieved thanks to the diodes D_9 and D_{10} , which decouple the two loops and drive the optocoupler OPT. The legs R_{23} - C_{11} and R_{24} - C_{12} are connected for feedback stabilization.

The zener diode D_{Z2} is connected at the non-inverting input of the voltage control operational amplifier in order to clamp the maximum voltage on the pin in any operative condition.

The PWM control is realized using the first operational amplifier to generate a sawtooth waveforms at 270 Hz (given by the leg R_{19} - C_{13}), which is compared with a variable voltage (set by the potentiometer R_{21}): the generated signal will drive the NPN transistor Q_3 . When the transistor is "ON", the SMPS works in "current control" mode limiting the max output current while, when the transistor is "OFF", it works in "voltage control" mode, regulating the output voltage below the LEDs threshold and consequently switching them off.

During the dimming operation, the transistor Q_3 is switched off and the voltage on pin 11 of IC2 is pulled up and limited to V_{DZ1} . Consequently, the VIPer stops switching and the output current falls to zero, while the output voltage decrease down to $V_{OUT} = n \cdot V_{F(OFF)}$, where n is the number of LEDs and $V_{F(OFF)}$ is the threshold voltage. Further decrease of the output voltage is not possible because of the high output impedance. Doing so, the output voltage never falls to zero, resulting in a big improvement in the dynamic behavior of the dimming function, with a slight impact on the efficiency $P_{DISS} = (V_{OUT} - V_{DZ2})/R_8$.

In open load condition, the maximum voltage is regulated by R_8 , R_9 and D_{Z2} according to the reference voltage given by ([Equation 5](#)).

Figure 11. Converter schematic for European input voltage range

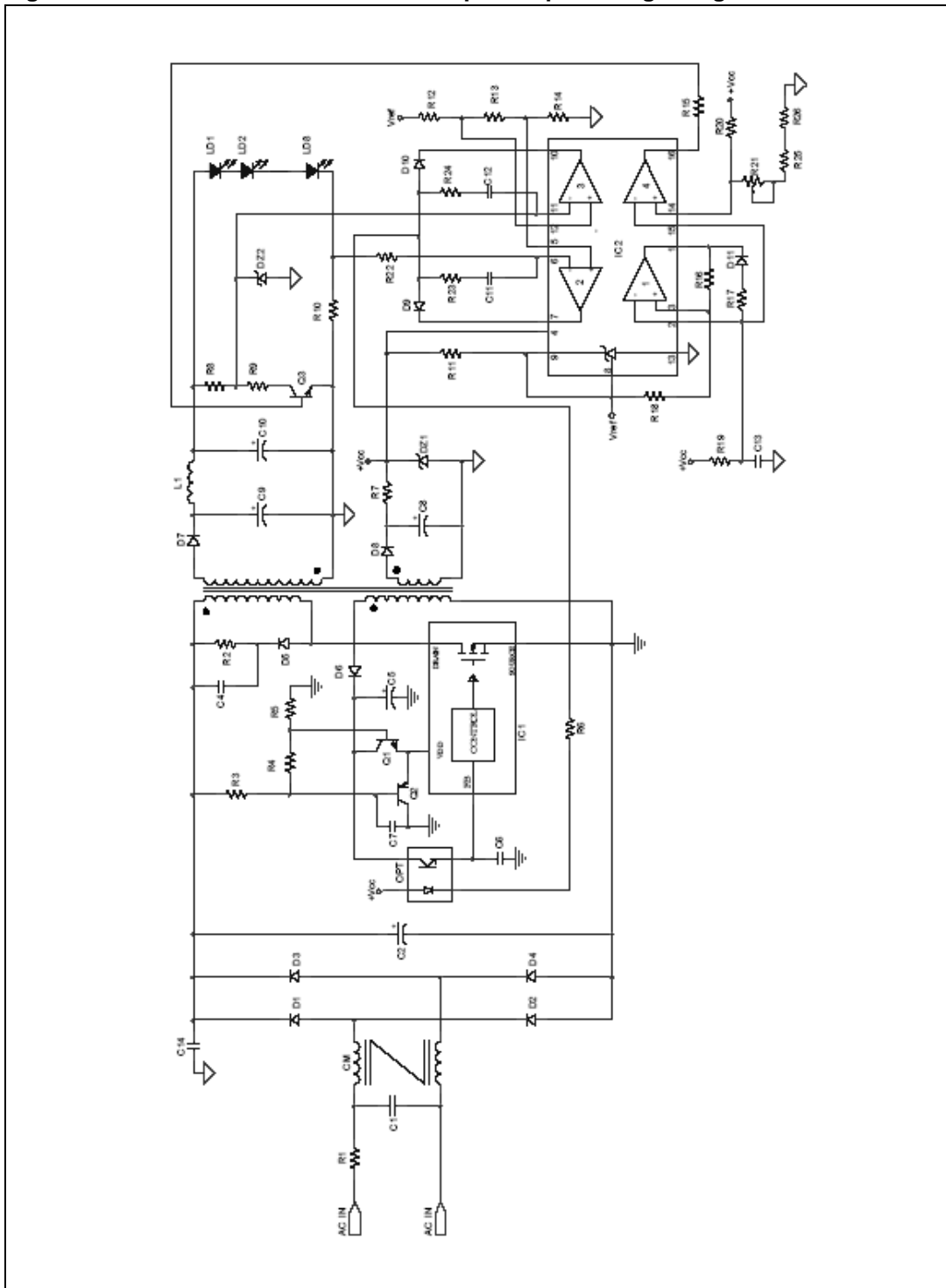

Table 4. Component list

Reference	Description	Note
FS	1 A-250 V	Fuse
R1	10., 1/2 W	Metallic oxide resistor – No flammable
R2	1M., 1/2 W	
R3	560 k., 1/4 W	
R4	12 k., 1/4 W	
R5	24 k., 1/4 W	
R6	1 k., 1/4 W	
R7	150., 1/2 W	
R8	5.6 k., 1/4 W	
R9	220., 1/4 W	
R10	0.47., 1/4 W	Sense resistor
R11	2.7 k., 1/4 W	
R12	12 k., 1/4 W	
R13	10 k., 1/4 W	
R14	1.5 k., 1/4 W	
R15	4.7 k., 1/4 W	
R16, R18, R22	22 k., 1/4 W	
R17	100., 1/4 W	
R19	33 k., 1/4 W	
R20	15 k., 1/4 W	
R21	20 k., 1/4 W	Potentiometer
R23, R24	220 k., 1/4 W	
R25	1.2 k., 1/4 W	
R26	6.8 k., 1/4 W	
C1	100 nF, 275 V	X2 Capacitor
C2	10 μ F, 400 V	Electrolytic capacitor
C4	100 pF, 630 V	Polypropylene capacitor
C5	33 μ F, 25 V	Electrolytic capacitor
C6, C13	220 nF	Polyester capacitor
C7	47 nF	Polyester capacitor
C8	33 μ F, 16 V	Electrolytic capacitor
C9	1 μ F, 50 V	Electrolytic capacitor
C10	3.3 μ F, 50 V	Electrolytic capacitor

Table 4. Component list (continued)

Reference	Description	Note
C11, C12	2.2 nF	Polyester Capacitor
C14	2.2 nF, 250 V	Y1 Capacitor
D1, D2, D3, D4	1N4007	
D5	STMicroelectronics STTH1R06	
D6, D8, D9, D10, D11	1N4148	
D7	STMicroelectronics STTH102	
DZ1, DZ2	Zener Diode 5.1 V, 1/4 W	
Q1, Q3	STMicroelectronics BC337	NPN transistor
Q2	STMicroelectronics BC327	PNP transistor
L1	47 μ H	Radial
TF	TDK SRW16ES-ExxH003	
CM	Coilcraft BU9-103R25B	2X10 mH Common mode choke
OPT	SFH610A	
IC1	STMicroelectronics VIPer22ADIP-E	
IC2	STMicroelectronics TSM104	

5.2 Transformer specifications

The transformer has four windings, included two auxiliaries. One is used to supply the VIPer and the other one to supply the TSM104 and the dimming control circuit on the secondary side.

Since the output voltage is variable between 3.5 V (with 1 LED) and 28 V (with 8 LEDs), the two auxiliary windings are coupled in forward mode to the primary winding.

In order to limit the reflected voltage to a maximum value (100 V), the primary-to-secondary turn's ratio has been set according to the maximum count of LEDs.

The transformer characteristics are listed in [Table 5](#) and the winding arrangement as well as the mechanical specifications are shown in [Figure 12](#)

5.3 DALI Interface

In order to control the board in remote fashion a connector has been introduced to interface it with the DALI reference design (ST7DALI-EVAL).

Referring to the schematic in [Appendix A](#), it is possible to move from analog control by the trimmer R₂₁ to the digital one by DALI, removing the jumper J1 and J2. Then, connect the 1..10 V output of the DALI interface on connector J2 of the ST7DALI-EVAL demo board to CN1 connector of the STEVAL-ILL001V1, providing the correct voltage range, i.e. from 0 to 2.5 V.

Figure 12. Transformer features: (a) schematic, (b) mechanical characteristics and (c) pinout

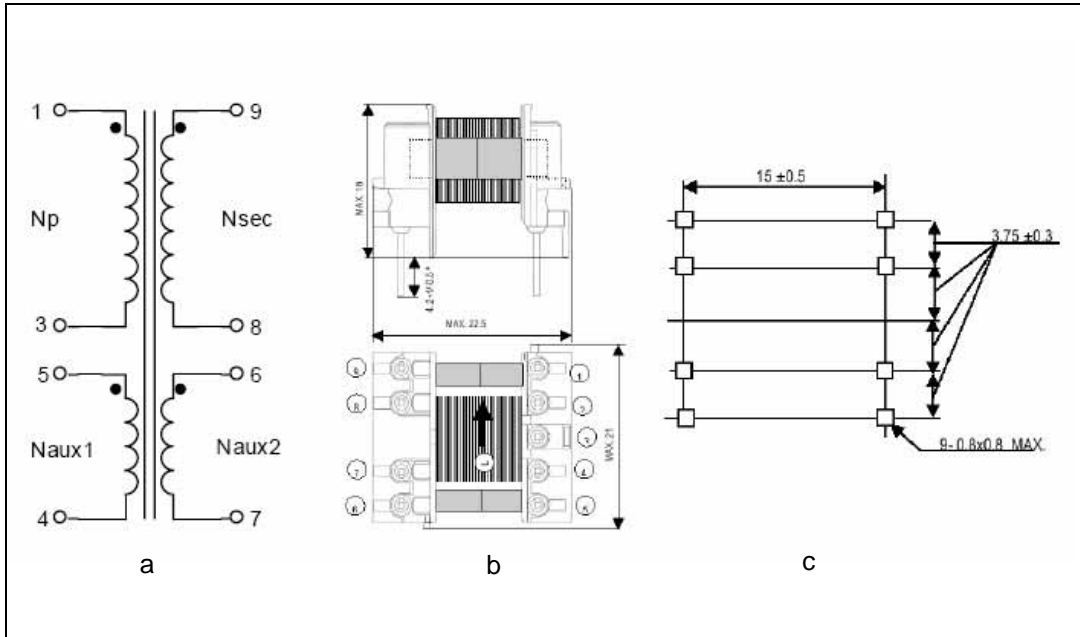

Table 5. Transformer specifications

Parameters	Value
Ferrite	PC40EF16
Core geometry	E16
Primary inductance	2.0 mH±12%
Leakage inductance	60 µH max
NP	135 turns – AWG 35
NAUX1	9 turns – AWG 35
NAUX2	5 turns – AWG 29
NSEC	36 turns – AWG 29

6 Experimental results

In this section typical waveforms are given under several load conditions. In [Figure 13](#) and [Figure 14](#) the drain-source voltage and the drain current at minimum load (1 LEDs) and full load (8 LEDs), at nominal input voltage (230 V_{AC}) are shown, respectively. In [Figure 15](#) the output current ripple is shown, which is fixed to about 20% I_{OUT}, in order to keep the output filter small and improve the output dynamic behavior.

In [Figure 17](#) to [Figure 22](#) the output current and drain-source voltage are shown during dimming operations. It is important to point out that the driver is able to dim the LEDs array down to 10% of its maximum luminosity.

In [Figure 23](#) and [Figure 24](#) typical waveforms of the dimming control section, as introduced in [Section 5.1](#), are shown: the sawtooth waveform, V_{SAW}, defines the dimming frequency while varying the reference voltage, V_{REF} by means of the potentiometer R₂₁, it is possible to change the PWM duty-cycle and consequently the LEDs luminosity. It is important to point out that the output voltage never goes to zero, but is always above a minimum value depending on the number of LEDs in the array. In [Figure 25](#) and [Figure 26](#) the output during dimming is shown.

Finally, [Figure 27](#) and [Figure 28](#) shows the drain voltage and output voltage in open load condition with 1 or 8 LEDs connected respectively. Under this condition the output voltage is limited to about 33 V both in steady state and dimming operation.

Figure 13. V_{DS} and I_D at 230 V_{AC}: 1 LED

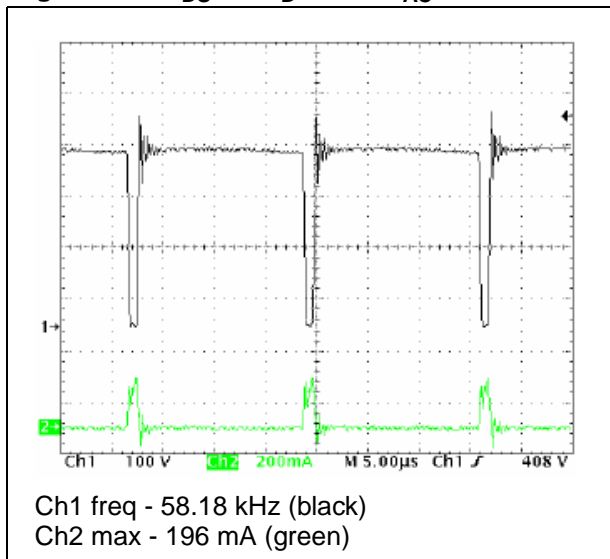

Figure 14. V_{DS} and I_D at 230 V_{AC}: 8 LEDs

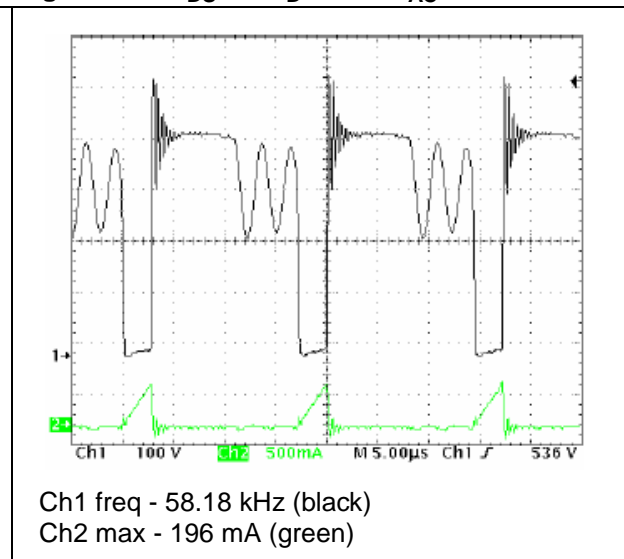

Figure 15. Typical waveforms: drain voltage and output current ripple at 230 V_{AC}

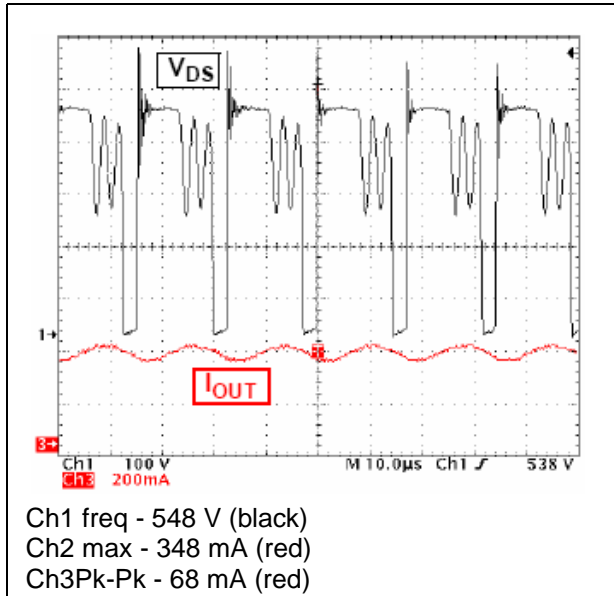

Figure 16. Typical waveforms: startup at 265 V_{AC}

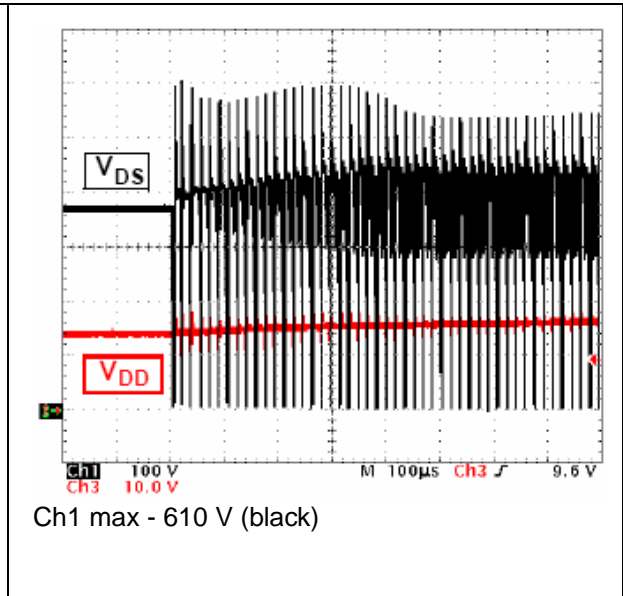

Figure 17. Drain voltage V_{DS} and output current I_{OUT}: 1 LED

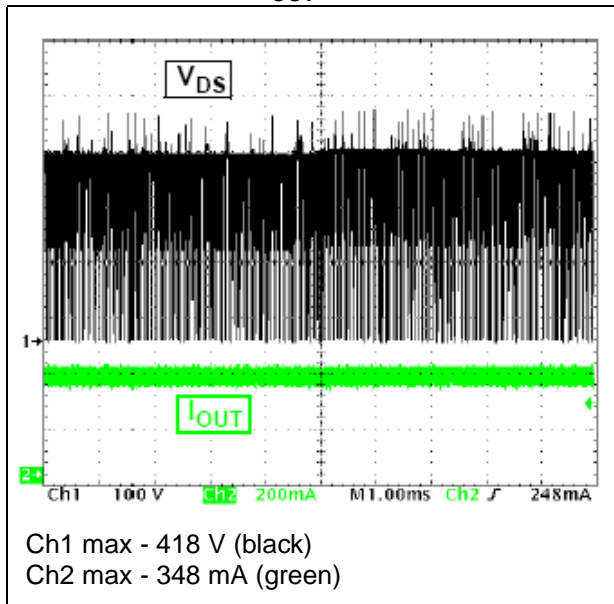

Figure 18. Drain voltage V_{DS} and output current I_{OUT}: 8 LEDs

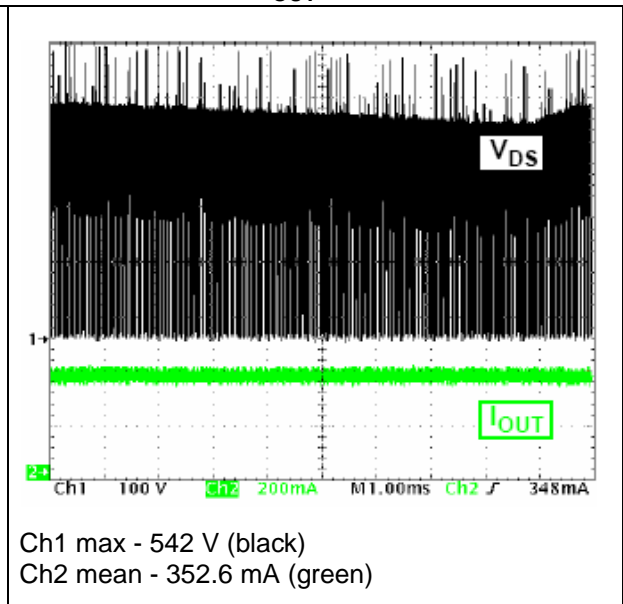

Figure 19. Drain voltage V_{DS} and output current I_{OUT} at 50% dimming: 1 LED

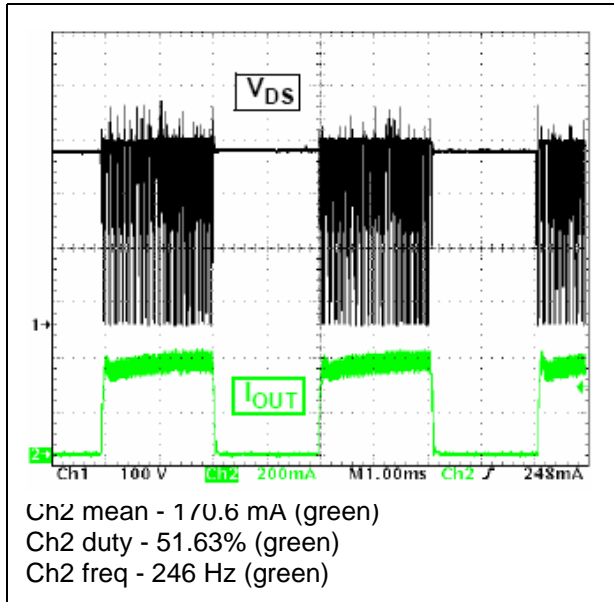

Figure 20. Drain voltage V_{DS} and output current I_{OUT} at 50% dimming: 8 LEDs

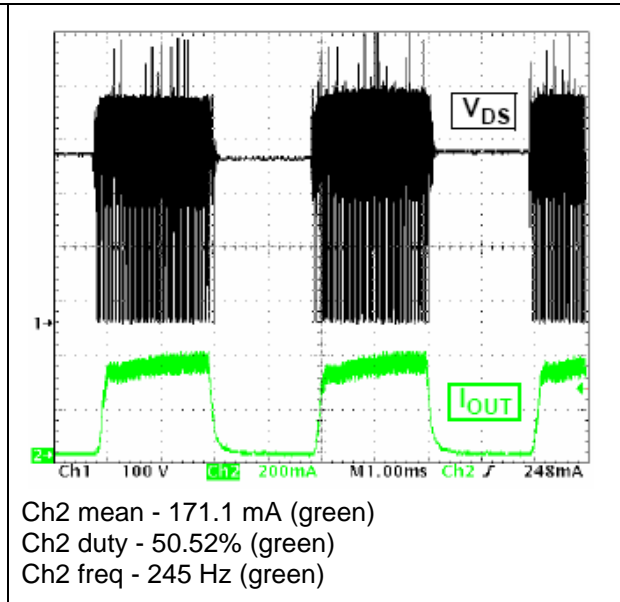

Figure 21. Drain voltage V_{DS} and output current I_{OUT} at 10% dimming: 1 LED

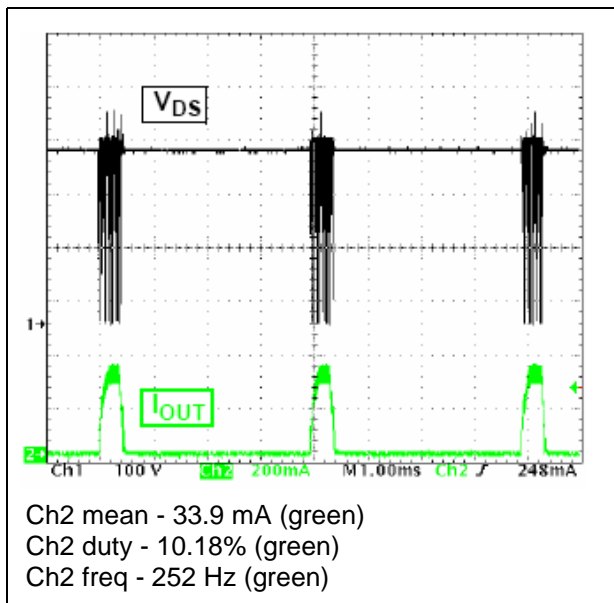

Figure 22. Drain voltage V_{DS} and output current I_{OUT} at 10% dimming: 8 LEDs

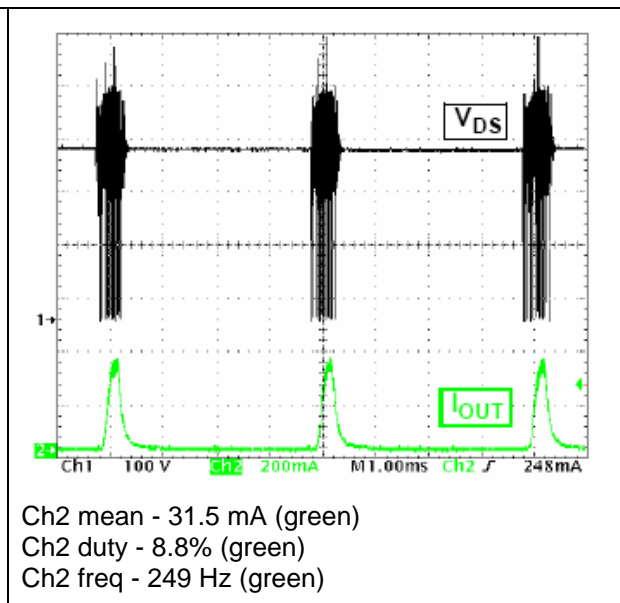

Figure 23. Control signals at 230 V_{AC}: 1 LED

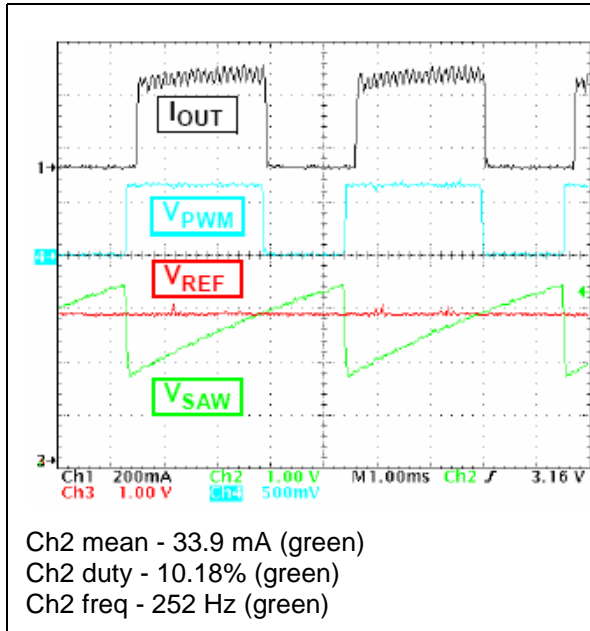

Figure 24. Control signals at 230 V_{AC}: 8 LEDs

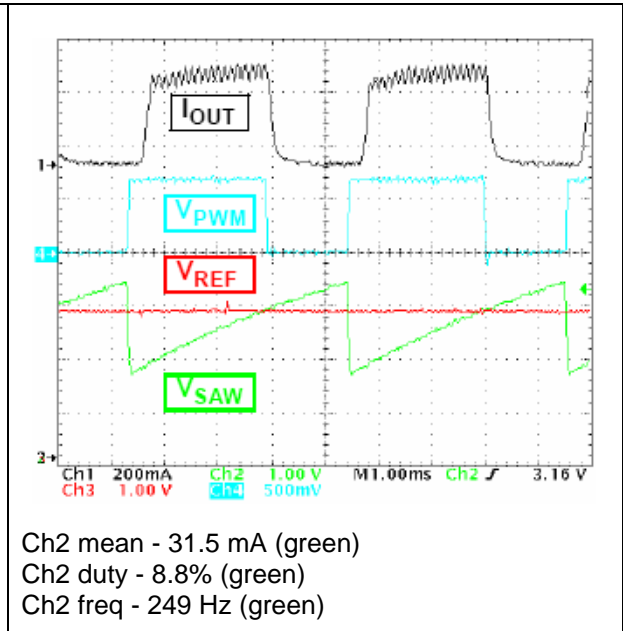

Figure 25. Control stage at 230 V_{AC}: 1 LED

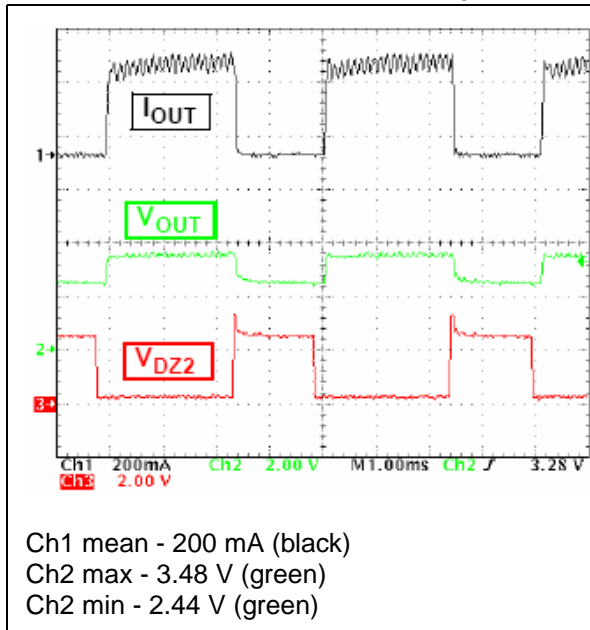

Figure 26. Control stage at 230 V_{AC}: 8 LEDs

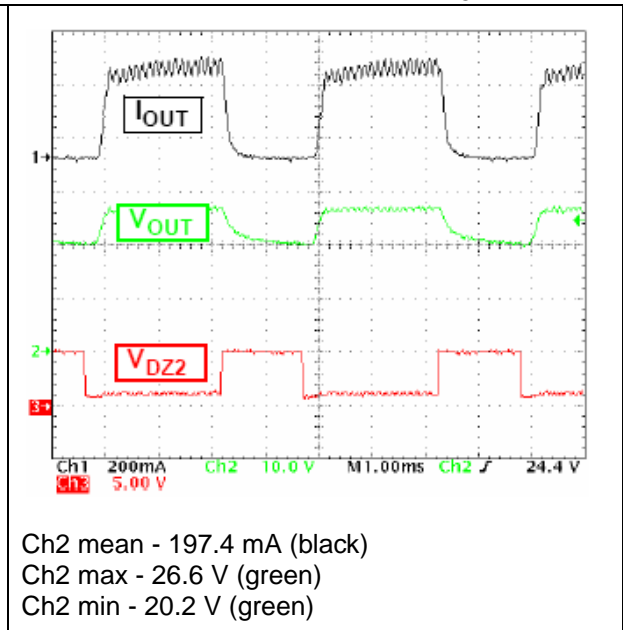

Figure 27. Open load condition at 230 V_{AC}: no dimming

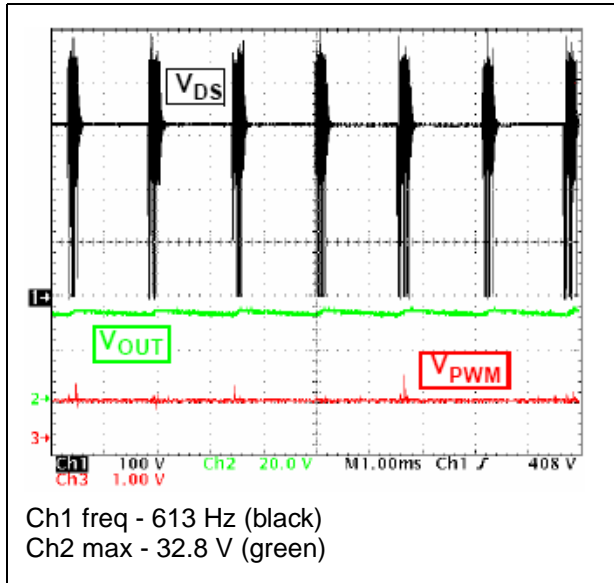
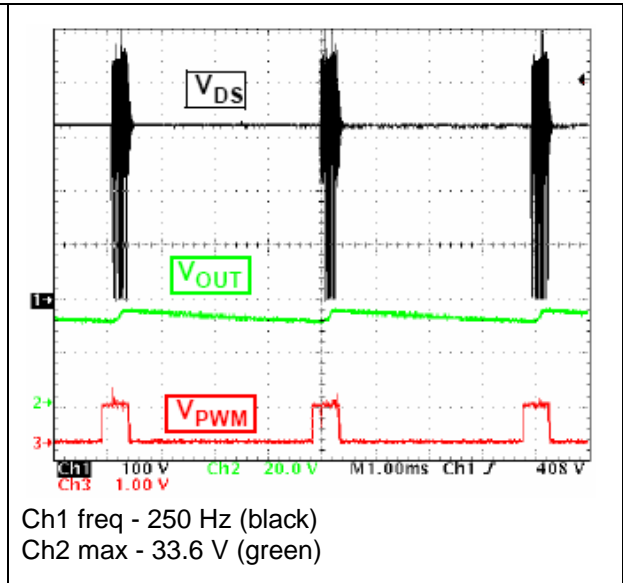
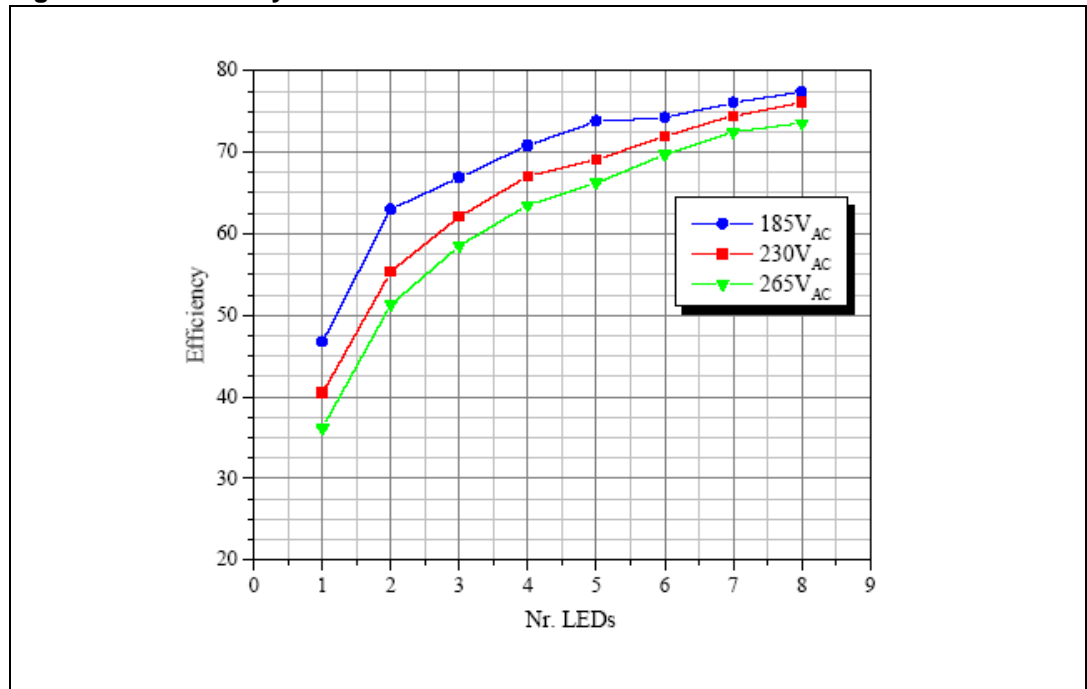

Figure 28. Open load condition at 230 V_{AC}: minimum dimming



The efficiency of the system, one of the key parameters of the application, has been measured in the whole input voltage range varying the number of LEDs from 1 to 8, and the experimental results are shown in [Figure 29](#).

Figure 29. Efficiency



7 Layout considerations

As any switched mode power supply, for proper operations, basic rules have to be taken into account in order to optimize the current path, especially in the routing of high current path. In fact, since EMI issues are also related to layout, the current loop area has to be minimized.

In addition to this, in order to avoid any noise interference between the control section and the power section, the control ground paths have to be kept separated from each other. All the high current traces have to be as short and wide as possible, in order to minimize the resistive and inductive effect.

A particular care has to be taken regarding the optimal routing of the input EMI filter path and the correct placement of any single component.

A final consideration regards the thermal management: a copper area has to be provided on the VIPer drain, in order to reduce the thermal resistance R_{th} and consequently keep the device temperature reasonably low. All the aforementioned considerations have been taken into account in the lab prototype, as shown in [Figure 30](#).

Figure 30. PCB layout (not in scale)

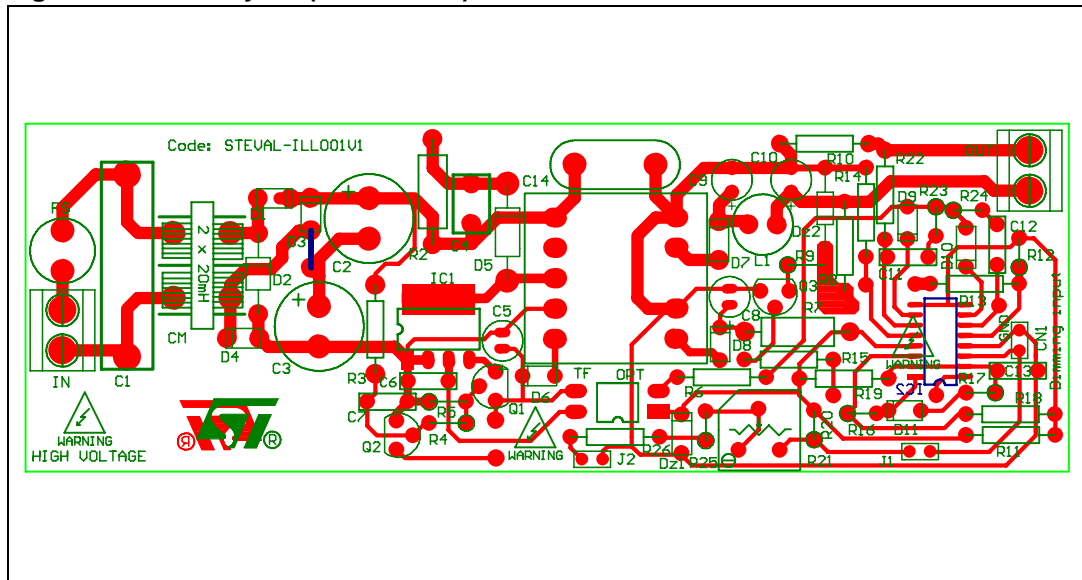

8 EMI measurements

Conducted EMI measurements have been performed according to EN55015:2000, the specific European standard on electrical lighting and similar equipment, using a 50 LISN and a spectrum analyzer with peak detector.

The results are shown in [Figure 31](#) and [Figure 32](#), for Line 1 and Line 2 respectively, under full load condition at nominal input voltage, i.e. 230 V_{AC}. The emissions level are well below the Quasi Peak limit although the measurements have been performed using the Peak detector, conforming the conducted EMI compliance of the system.

Figure 31. Conducted emissions at full load: line 1 emissions

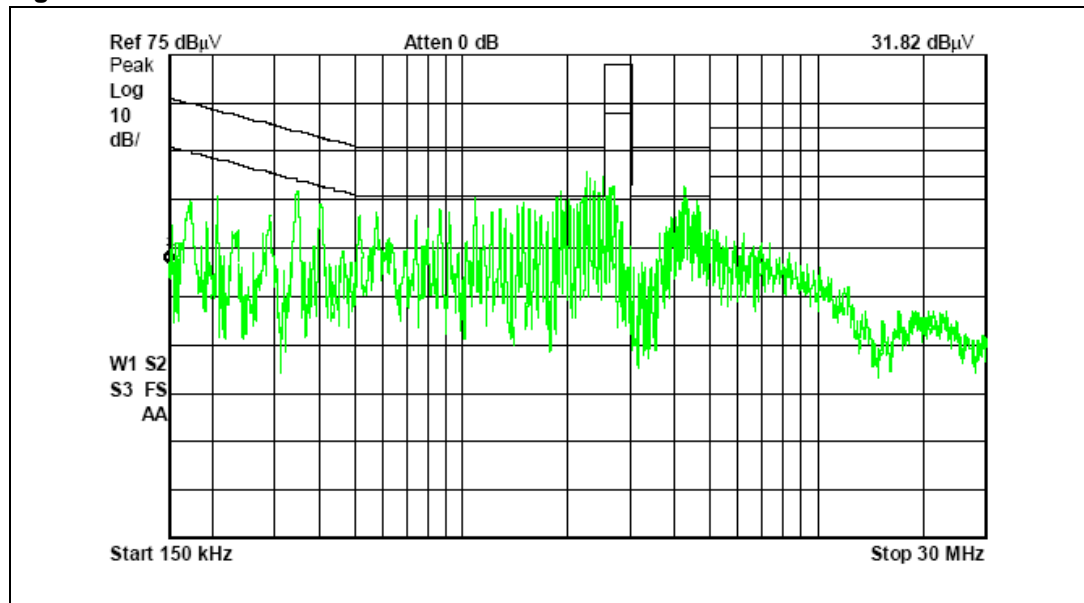
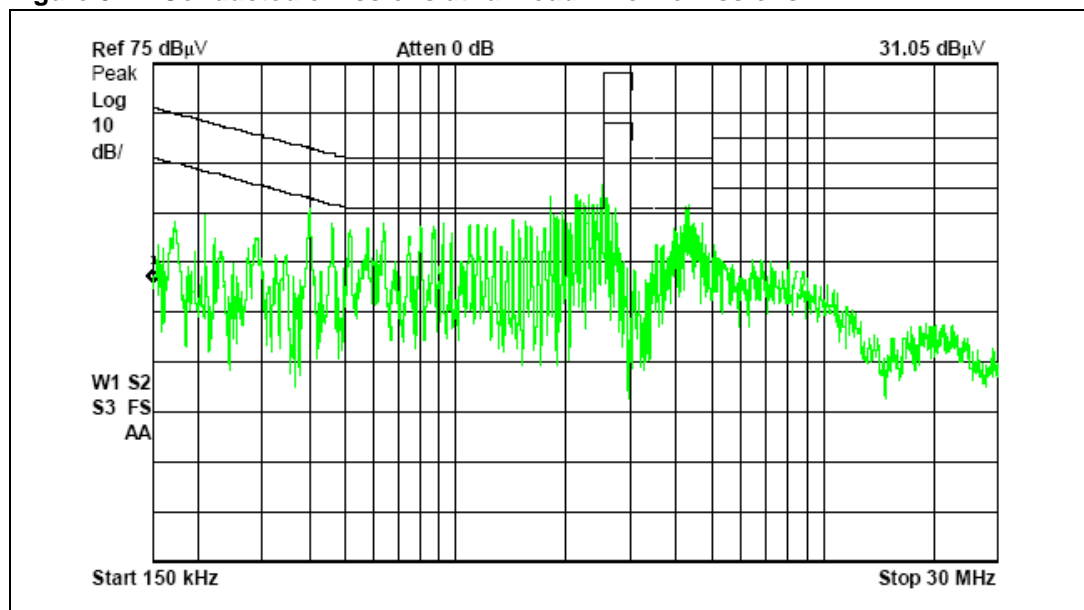

Figure 32. Conducted emissions at full load: line 2 emissions



10 Input section arrangement for U.S. market

The proposed system has been designed for the European voltage range, i.e. 187-264 V_{AC}, but by means of a voltage doubler, consisting of D₁-D₂ and C₂-C₃, it can also be used with the U.S. voltage range, i.e. 88-132 V_{AC}. The only modification needed is related to the input capacitor C₂ which has to be replaced by two capacitors C₂ and C₃ with half the value of the European voltage range, connected as shown in [Figure 34](#).

Figure 34. Application circuit for U.S. input voltage range: changes on the input section

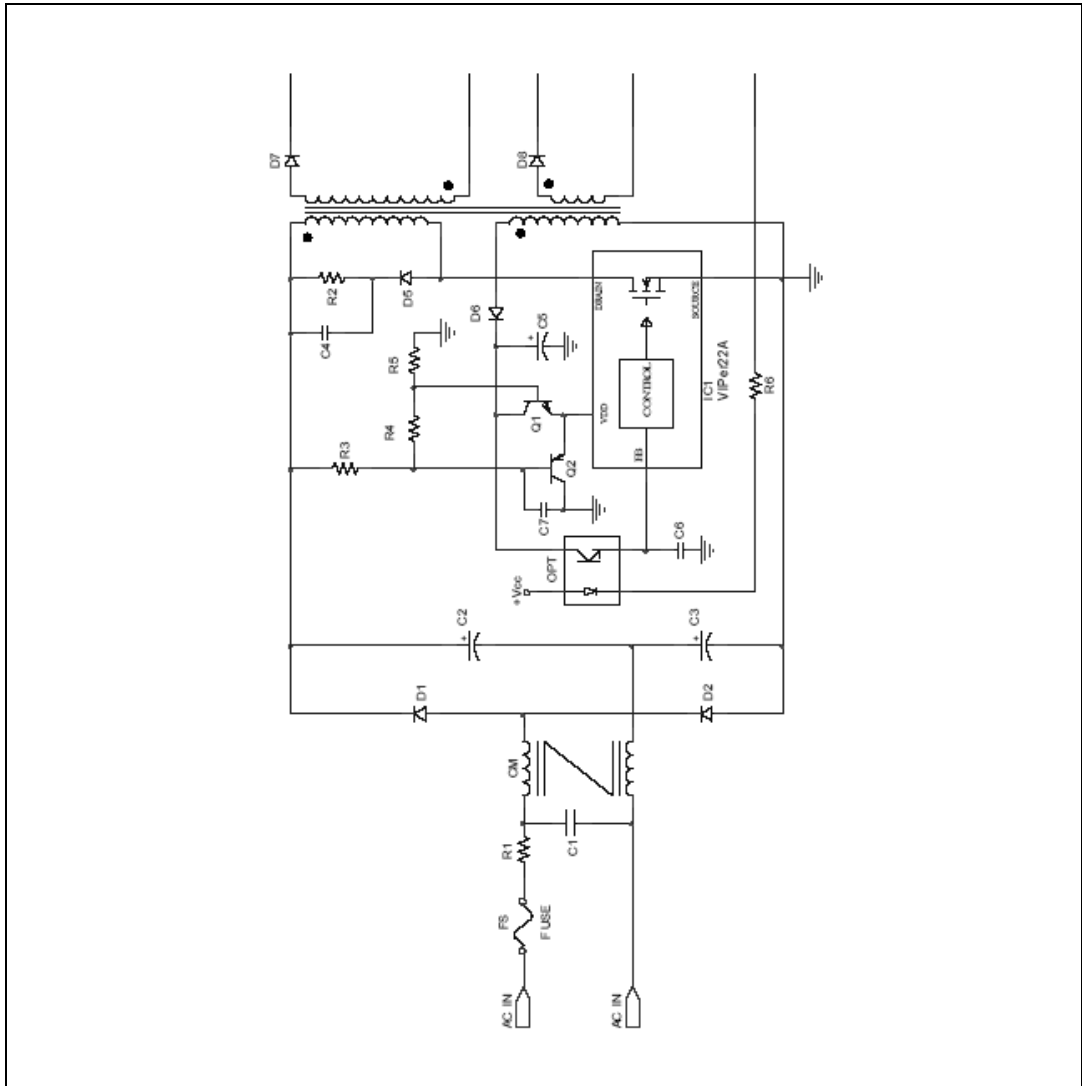

11 Conclusions

In this document an innovative solution for driving high efficiency LEDs has been introduced.

The power converter is based on a flyback topology with the smart power VIPer22A-E. It is able to drive with no circuital modifications 1 to 8 LEDs array and to perform an optimal dimming function by means of a patented PWM technique. A simplified version of the system has also been introduced in order to address the low end applications which do not require the dimming function.

A lab prototype has been developed and fully tested under several conditions, confirming the suitability of the proposed approach to such an emerging application.

The reference board will be available at stock through the order code: STEVAL-ILL001V1.

Appendix A STEVAL-ILL001V1 schematic

Figure 35. STEVAL-ILL001V1 Schematic

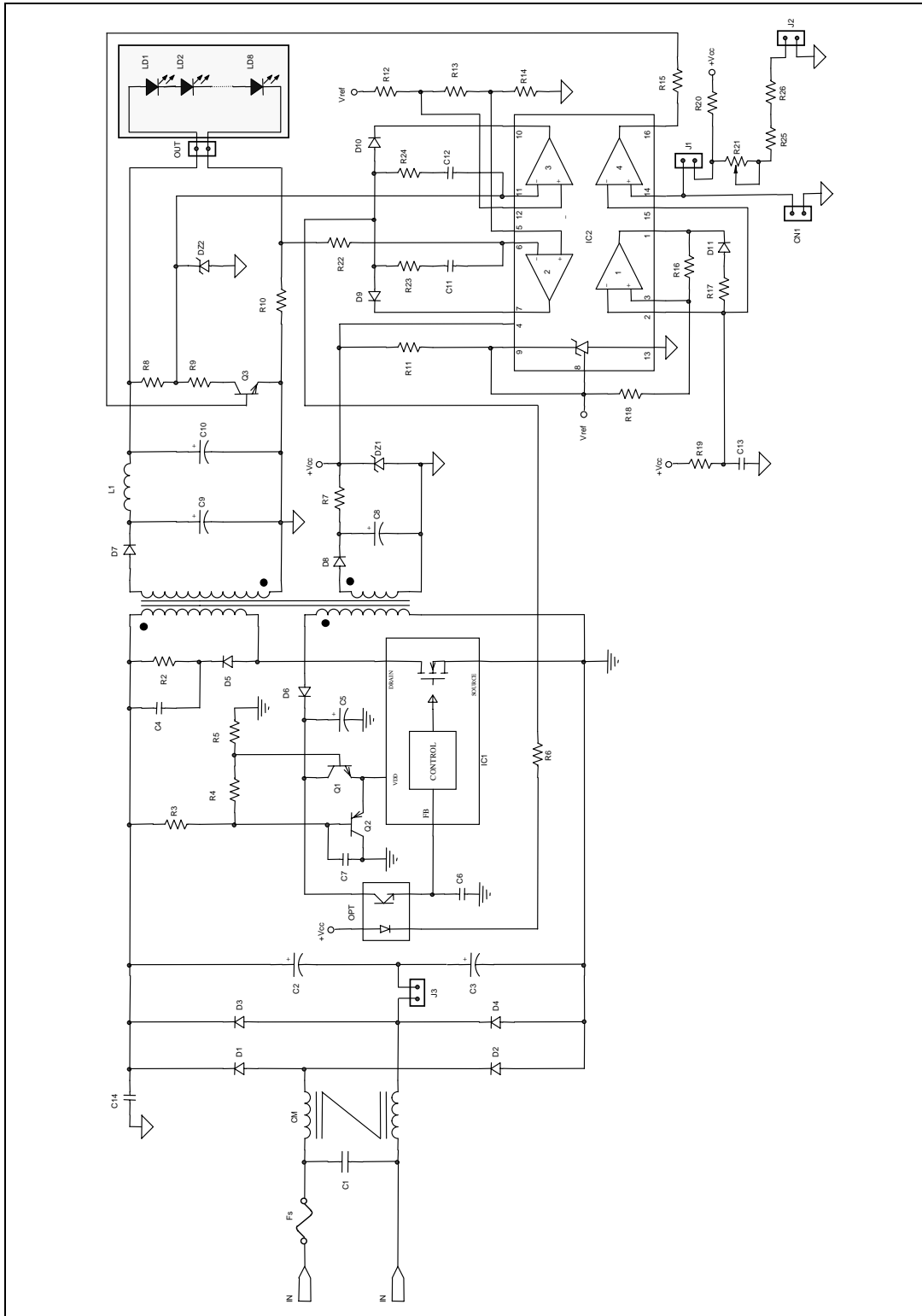

12 Revision history

Table 6. Revision history

Date	Revision	Changes
Oct-2004	1	First issue
Feb-2005	2	D5 & Q2 values change in component list table
Feb-2005	3	– Figure in cover page changed – Bil of material modified
21-Mar-2007	4	– The document has been reformatted – Figure in cover page changed – PCB layout changed – STEVAL-ILL001V1 Schematic insertion

Please Read Carefully:

Information in this document is provided solely in connection with ST products. STMicroelectronics NV and its subsidiaries ("ST") reserve the right to make changes, corrections, modifications or improvements, to this document, and the products and services described herein at any time, without notice.

All ST products are sold pursuant to ST's terms and conditions of sale.

Purchasers are solely responsible for the choice, selection and use of the ST products and services described herein, and ST assumes no liability whatsoever relating to the choice, selection or use of the ST products and services described herein.

No license, express or implied, by estoppel or otherwise, to any intellectual property rights is granted under this document. If any part of this document refers to any third party products or services it shall not be deemed a license grant by ST for the use of such third party products or services, or any intellectual property contained therein or considered as a warranty covering the use in any manner whatsoever of such third party products or services or any intellectual property contained therein.

UNLESS OTHERWISE SET FORTH IN ST'S TERMS AND CONDITIONS OF SALE ST DISCLAIMS ANY EXPRESS OR IMPLIED WARRANTY WITH RESPECT TO THE USE AND/OR SALE OF ST PRODUCTS INCLUDING WITHOUT LIMITATION IMPLIED WARRANTIES OF MERCHANTABILITY, FITNESS FOR A PARTICULAR PURPOSE (AND THEIR EQUIVALENTS UNDER THE LAWS OF ANY JURISDICTION), OR INFRINGEMENT OF ANY PATENT, COPYRIGHT OR OTHER INTELLECTUAL PROPERTY RIGHT.

UNLESS EXPRESSLY APPROVED IN WRITING BY AN AUTHORIZED ST REPRESENTATIVE, ST PRODUCTS ARE NOT RECOMMENDED, AUTHORIZED OR WARRANTED FOR USE IN MILITARY, AIR CRAFT, SPACE, LIFE SAVING, OR LIFE SUSTAINING APPLICATIONS, NOR IN PRODUCTS OR SYSTEMS WHERE FAILURE OR MALFUNCTION MAY RESULT IN PERSONAL INJURY, DEATH, OR SEVERE PROPERTY OR ENVIRONMENTAL DAMAGE. ST PRODUCTS WHICH ARE NOT SPECIFIED AS "AUTOMOTIVE GRADE" MAY ONLY BE USED IN AUTOMOTIVE APPLICATIONS AT USER'S OWN RISK.

Resale of ST products with provisions different from the statements and/or technical features set forth in this document shall immediately void any warranty granted by ST for the ST product or service described herein and shall not create or extend in any manner whatsoever, any liability of ST.

ST and the ST logo are trademarks or registered trademarks of ST in various countries.

Information in this document supersedes and replaces all information previously supplied.

The ST logo is a registered trademark of STMicroelectronics. All other names are the property of their respective owners.

© 2007 STMicroelectronics - All rights reserved

STMicroelectronics group of companies

Australia - Belgium - Brazil - Canada - China - Czech Republic - Finland - France - Germany - Hong Kong - India - Israel - Italy - Japan - Malaysia - Malta - Morocco - Singapore - Spain - Sweden - Switzerland - United Kingdom - United States of America

www.st.com